

48Gbps 8K 8x8 HDMI™ Matrix



User Manual

VER 1.1

Thank you for purchasing this product

For optimum performance and safety, please read these instructions carefully before connecting, operating or adjusting this product. Please keep this manual for future reference.

Surge protection device recommended

This product contains sensitive electrical components that may be damaged by electrical spikes, surges, electric shock, lighting strikes, etc. Use of surge protection systems is highly recommended in order to protect and extend the life of your equipment.

Caution

The product requires the use of UTP connectors. Please connect in direct interconnection method and do not cross connect.

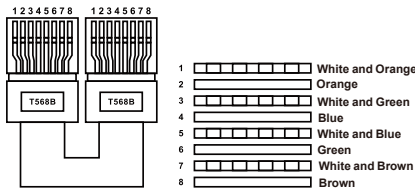

Direct Interconnection Method

Table of Contents

1. Introduction.....	1
2. Features.....	1
3. Package Contents.....	1
4. Specifications.....	2
5. Operation Controls and Functions.....	3
5.1 Front Panel.....	3
5.2 Rear Panel.....	4
5.3 LCD Display Navigation.....	5
6. IR Remote.....	7
7. IR Cable Pin Assignment.....	8
8. EDID Management.....	9
9. Web GUI User Guide.....	11
10. RS-232 Control Command.....	23
11. Application Example.....	30

1. Introduction

The 48Gbps 8K 8x8 HDMI Matrix supports the transmission of high resolution video (resolution up to 4K2K@120Hz 4:4:4 12bit and 8K4K@60Hz 4:2:0 12bit) and multi-channel digital audio (such as LPCM 7.1CH, Dolby Atmos, Dolby TrueHD, Dolby Digital Plus and DTS-HD Master Audio) from 8 HDMI sources to 8 HDMI displays. Resolution downscaling and HDR conversion for each HDMI output are also supported.

It works with Blue-Ray players, Set-Top boxes, Home Theater PCs, and game consoles which connect to an HDMI display, and can be controlled via front panel buttons, IR remote, RS-232, and Web GUI.

2. Features

- ☆ HDCP 2.3 compliant
- ☆ 8 × HDMI inputs can be independently routed to 8 × HDMI outputs
- ☆ Video resolution is up to 8K60Hz 4:2:0, 8K30Hz 4:4:4 and 4K120Hz 4:4:4, as specified in HDMI 2.1
- ☆ Support 48Gbps video bandwidth
- ☆ HDR, HDR10, HDR10+, Dolby Vision pass-through
- ☆ Support resolution downscaling and HDR conversion for each output port
- ☆ VRR, ALLM, QMS, QFT, SBTM are supported
- ☆ Support optical audio and balanced analog audio output
- ☆ Advanced EDID management
- ☆ Control via front panel buttons, IR remote, RS-232, and Web GUI

3. Package Contents

- ① 1 × 48Gbps 8K 8×8 HDMI Matrix
- ② 1 × 24V/3.75A Locking Power Adapter
- ③ 1 × IR Remote
- ④ 1 × IR Wideband Receiver Cable (12V, 1.5m)
- ⑤ 1 × AC Power Cord (1.5m)
- ⑥ 1 × RS-232 Serial Cable (1.5m, male to female head)
- ⑦ 8 × 5pin-3.81mm Phoenix Connector
- ⑧ 8 × Machine Screw (KM3*6)
- ⑨ 2 × Mounting Ear
- ⑩ 1 × User Manual

4. Specifications

Technical				
HDMI Compliance	HDMI 2.1			
HDCP Compliance	HDCP 2.3			
Video Bandwidth	48Gbps			
Video Resolution	Up to 8K60Hz 4:2:0, 8K30Hz 4:4:4 and 4K120Hz 4:4:4			
Color Space	RGB_4:4:4, YCbCr_4:4:4, YCbCr_4:2:2, YCbCr_4:2:0			
Color Depth	8/10/12-bit			
HDR Formats	HDR, HDR10, HDR10+, Dolby Vision, HLG			
Audio Formats	HDMI IN/OUT: LPCM, Dolby Digital/Plus/EX, Dolby True HD, Dolby Atmos, DTS, DTS-EX, DTS-96/24, DTS High Res, DTS-HD Master Audio, DSD AUDIO BREAKOUT: Optical Outputs: LPCM 2.0CH/Dolby/DTS 5.1CH Balanced Analog Audio Outputs: LPCM 2CH			
ESD Protection	IEC 61000-4-2: ±8kV (Air-gap discharge) & ±4kV (Contact discharge)			
Connection				
Input ports	8 × HDMI INPUT [Type A, 19-pin female]			
Output ports	8 × HDMI OUTPUT [Type A, 19-pin female] 8 × OPTICAL AUDIO OUT [S/PDIF] 8 × AUDIO OUT [3.5mm Stereo Mini-jack]			
Control ports	1 × TCP/IP [RJ45] 1 × RS-232 [D-Sub 9] 1 × IR EXT [3.5mm, Stereo Mini-jack]			
Mechanical				
Housing	Metal Enclosure			
Color	Black			
Dimensions	440mm [W] × 203mm [D] × 44.5mm [H]			
Weight	2.94kg			
Power Supply	Input: AC 100-240V 50/60Hz, Output: DC 24V/3.75A (US/EU standard, CE/FCC/UL certified)			
Power Consumption	70W (Max)			
Operating Temperature	32 - 104°F / 0 - 40°C			
Storage Temperature	-4 - 140°F / -20 - 60°C			
Operating Humidity	20%~80% relative humidity, non-condensing			
Storage Humidity	10%~90% relative humidity, non-condensing			
Video Resolution	8K	4K60	4K30	1080P
HDMI Cable Length (HDMI IN / OUT)	3m/9.8ft (Ultra HDMI 2.1)	5m/16ft	10m/33ft	15m/49ft
The use of "Premium High Speed HDMI" cable is highly recommended.				

5. Operation Controls and Functions

5.1 Front Panel

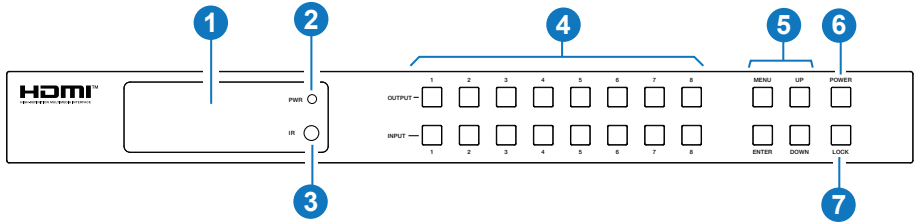

NO.	Name	Function Description
1	LCD screen	Display matrix switching status, input / output port, EDID, Baud rate, IP Address, etc.
2	PWR Indicator	The LED is on green when the device is working. The LED is on red when the device is on standby.
3	IR	IR signal receiver. Receiving the signal from the IR remote.
4	INPUT / OUTPUT buttons	You need to press an output button (1~8) firstly and then press an input button (1~8) to select the corresponding input source for the output port.
5	MENU / ENTER / UP / DOWN	Take RESET, for example. ① On the initial LCD display screen, press "MENU" button. There are OUTPUT/INPUT/EXTAUDIO/SETUP items to be selected. ② Press the "UP/DOWN" button to select SETUP item. ③ Press the "ENTER" button to enter into the next menu. There are LCD ONTIME/BAUDRATE/IP INFO/REBOOT/RESET items to be selected. ④ Press the "UP/DOWN" button to select RESET item. ⑤ Press the "ENTER" button to confirm reset. It will prompt: RESET SUCCESS! Note: Pressing the "MENU" button will return to the previous menu.
6	POWER button	Long press the POWER button for 1 seconds to enter the standby mode, then short press it to wake up the device.
7	LOCK button	Short press the LOCK button to lock front panel buttons (Except the power button); Press it again to unlock.

5.2 Rear Panel

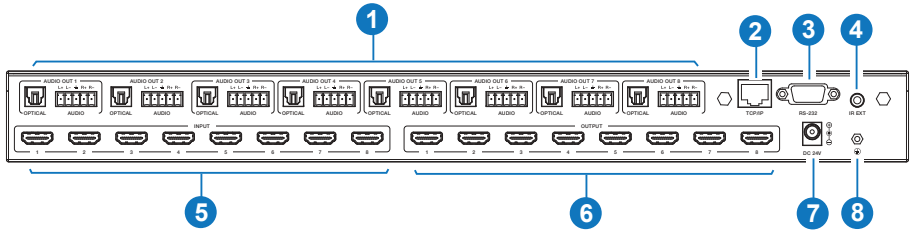

NO.	Name	Function Description
1	AUDIO OUT (1~8)	OPTICAL: Optical audio output port, connected to an audio output device such as audio amplifier. L/R AUDIO: Analog audio output port, supporting balanced/unbalanced audio output, with a maximum support of 2Vrms. Balanced connection method: L+, L-, $\frac{\perp}{\perp}$, R+, R- Unbalanced connection method: L+, $\frac{\perp}{\perp}$, R+
2	TCP/IP	TCP/IP control port, connected to PC or router with an UTP cable to control the matrix through Web.
3	RS-232 port	Connect to a PC or control system by D-Sub 9-pin cable to transmit RS-232 command.
4	IR EXT	If the IR receiver window of the unit is blocked or the unit is installed in a closed area out of infrared line of sight, the IR receiver cable can be inserted to the "IR EXT" port to receive the IR remote signal.
5	HDMI INPUT ports (1~8)	HDMI input ports, connected to HDMI source device such as 8K computer, DVD or set-top box with an HDMI cable.
6	HDMI OUTPUT ports (1~8)	HDMI output ports, connected to HDMI display device such as TV or monitor with an HDMI cable.
7	DC 24V	Connect to 24V/3.75A power adapter.
8	GND	Connect the housing to the ground.

Note:

1. You can restore the factory settings via the front panel, web or RS-232 command.
2. Power cut memory function is available except for standby status.
3. The RS-232 and Web will be available in a few minutes when the device is powered on.

5.3 LCD Display Navigation

The buttons on the the front panel are used for LCD display navigation, including INPUT(1~8), OUTPUT(1~8), MENU, ENTER, UP, DOWN.

Menu contents are as follows:

Level 1	Level 2	Level 3	Level 4
OUTPUT	VID MODE	OUT1/OUT2/OUT3/OUT4/ OUT5/OUT6/OUT7/OUT8	BYPASS
			8K to 4K
			8K/4K to 1080P
			AUTO
	HDR	OUT1/OUT2/OUT3/OUT4/ OUT5/OUT6/OUT7/OUT8	BYPASS
			HDR to SDR
	ARC	OUT1/OUT2/OUT3/OUT4/ OUT5/OUT6/OUT7/OUT8	ON
			OFF
	STREAM	OUT1/OUT2/OUT3/OUT4/ OUT5/OUT6/OUT7/OUT8	ENABLE
			DISABLE
	AUD MUTE	OUT1/OUT2/OUT3/OUT4/ OUT5/OUT6/OUT7/OUT8	ON
			OFF
INPUT	EDID	IN1/IN2/IN3/IN4 /IN5/IN6/IN7/IN8	z=1. 1080P, 2.0CH, z=2. 1080P, 5.1CH, z=3. 1080P, 7.1CH, z=4. 4K30, 2.0CH, z=5. 4K30, 5.1CH, z=6. 4K30, 7.1CH, z=7. 4K60(420), 2.0CH, z=8. 4K60(420), 5.1CH, z=9. 4K60(420), 7.1CH, z=10. 4K60(444), 2.0CH, z=11. 4K60(444), 5.1CH, z=12. 4K60(444), 7.1CH, z=13. 1080P_HDR, 2.0CH, z=14. 1080P_HDR, 5.1CH, z=15. 1080P_HDR, 7.1CH, z=16. 4K30_HDR, 2.0CH, z=17. 4K30_HDR, 5.1CH, z=18. 4K30_HDR, 7.1CH, z=19. 4K60(420)_HDR, 2.0CH, z=20. 4K60(420)_HDR, 5.1CH, z=21. 4K60(420)_HDR, 7.1CH z=22. 4K60(444)_HDR, 2.0CH, z=23. 4K60(444)_HDR, 5.1CH, z=24. 4K60(444)_HDR, 7.1CH, z=25. 4K120(420)_HDR, 2.0CH, z=26. 4K120(420)_HDR, 5.1CH, z=27. 4K120(420)_HDR, 7.1CH z=28. 4K120(444)_HDR, 2.0CH, z=29. 4K120(444)_HDR, 5.1CH, z=30. 4K120(444)_HDR, 7.1CH, z=31. FRL10G_8K_HDR, 2.0CH, z=32. FRL10G_8K_HDR, 5.1CH, z=33. FRL10G_8K_HDR, 7.1CH, z=34. FRL12G_8K_HDR, 2.0CH, z=35. FRL12G_8K_HDR, 5.1CH, z=36. FRL12G_8K_HDR, 7.1CH, z=37. user1_EDID, z=38. user2_EDID, z=39. user3_EDID, z=40. copy out1 z=41. copy out2 z=42. copy out3 z=43. copy out4 z=44. copy out5 z=45. copy out6 z=46. copy out7 z=47. copy out8

Level 1	Level 2	Level 3	Level 4
EXTAUDIO	OUT	OUT1/OUT2/OUT3/OUT4/OUT5/ OUT6/OUT7/OUT8	ENABLE
			DISABLE
	MODE	BIND to INPUT	/
		BIND to OUTPUT	/
AUDIO MATRIX		/	
MATRIX	OUT1/OUT2/OUT3/OUT4/ OUT5/OUT6/OUT7/OUT8	INPUT1 INPUT2 INPUT3 INPUT4 INPUT5 INPUT6 INPUT7 INPUT8 OUTPUT1 ARC OUTPUT2 ARC OUTPUT3 ARC OUTPUT4 ARC OUTPUT5 ARC OUTPUT6 ARC OUTPUT7 ARC OUTPUT8 ARC	
SETUP	LCD ONTIME	OFF ALWAYS ON 15 SECONDS 30 SECONDS 60 SECONDS	/
	BAUDRATE	4800 9600 19200 38400 57600 115200	/
	IP INFO	DHCP: ON/OFF 192.168.0.100	/
	REBOOT	SUCCESS!	/
	RESET	SUCCESS!	/

6. IR Remote

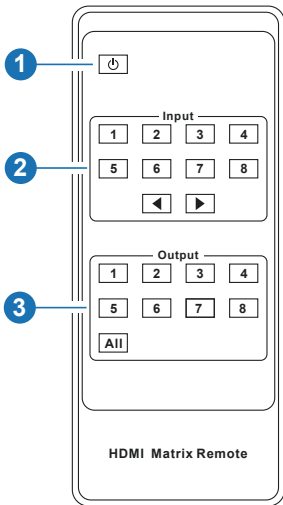

① Power on or Standby:

Power on the Matrix or set it to standby mode.

② Input 1/2/3/4/5/6/7/8:

Press to select input source.



Press to select the last or next input source.

③ Output 1/2/3/4/5/6/7/8:

Press to select output channel.

All:

Select all output channel simultaneously. For example, when you press the “All” button and then press input “1” button, at this time the input “1” source will output to all display devices.

Operation instruction:

You need to press the output button firstly and then press input button to select the corresponding input source. For example, press Output-X (X means output button from 1 to 8, including “All” button), then press Input-Y (Y means input button from 1 to 8).

The Matrix can be selected input source and output channel by using the IR remote. There are two ways to receive the IR remote signal.

The first way: The IR window accepts the IR remote signal. Using the IR remote, the furthest distance is 8 meters when the IR remote is directly faced to the matrix, and 5 meters when the using angle is $\pm 45^\circ$. The diagram is shown as below:

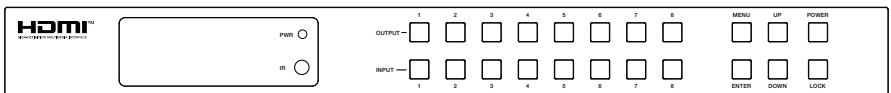

IR remote of the Matrix

The second way: If the IR receiver window of the Matrix is blocked or the Matrix is installed in a closed area out of infrared line of sight, the IR receiver cable can be inserted to the “IR EXT” port to receive the IR remote signal. The furthest distance of using the IR remote is 5 meters when the IR remote is directly faced to the IR receiver head, and 3 meters when the using angle is $\pm 45^\circ$. The diagram is shown as below.

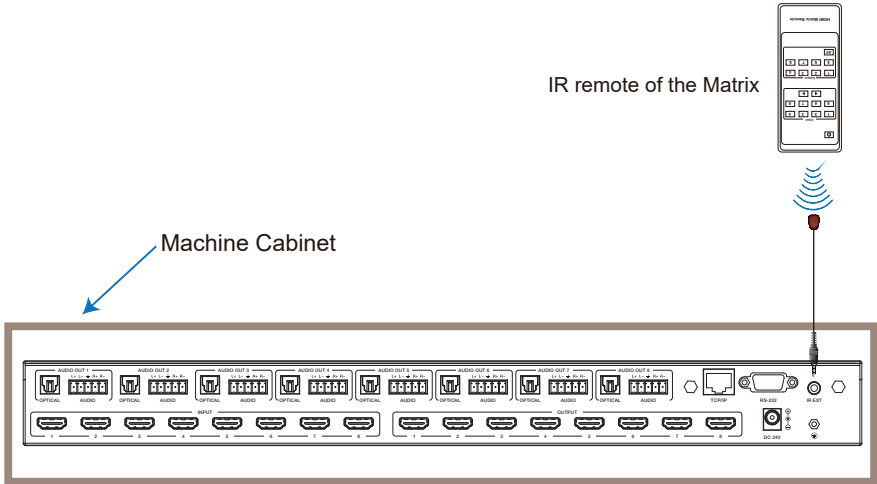

7. IR Cable Pin Assignment

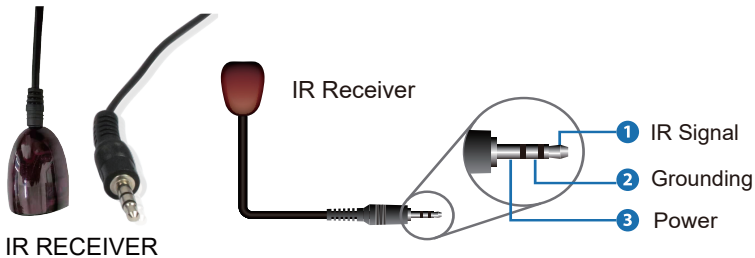

8. EDID Management

This Matrix has 36 factory defined EDID settings, 3 user-defined EDID modes and 8 copy EDID modes. You can select defined EDID mode or copy EDID mode to input port through front panel buttons, RS-232 control or Web GUI.

On-panel button operation: On the initial LCD display screen, press “MENU” button to enter the first level menu, press “UP/DOWN” button to select INPUT, and then press the “ENTER” button. Now the EDID item appears. Press the “ENTER” button, and then press “UP/DOWN” button to select the EDID mode you need. Then press “ENTER” button to confirm this operation.

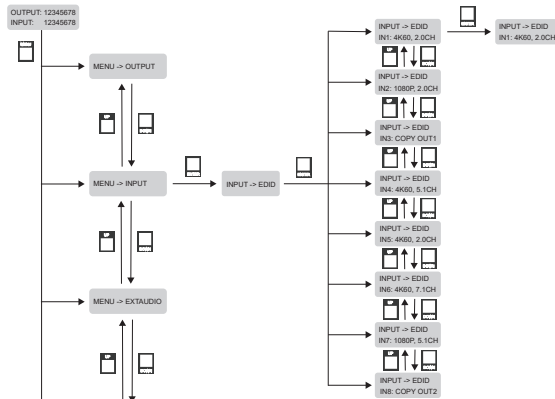

Note: Pressing the "MENU" button will return to the previous menu.

RS-232 control operation: Connect the Matrix to PC with a serial cable, then open a Serial Command tool on PC to send ASCII command “s input x EDID z!” to set EDID. For details, please refer to “EDID Setting” in the ASCII command list of “10. RS-232 Control Command”.

Web GUI Operation: Please check the EDID management in the “Input page” of “9. Web GUI User Guide”.

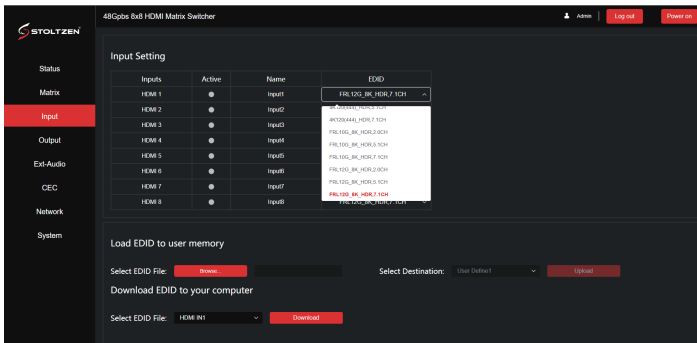

The defined EDID setting list of the product is shown as below:

EDID Mode	EDID Description	EDID Mode	EDID Description
1	1080P, 2.0CH	25	4K120(420)_HDR, 2.0CH
2	1080P, 5.1CH	26	4K120(420)_HDR, 5.1CH
3	1080P, 7.1CH	27	4K120(420)_HDR, 7.1CH
4	4K30, 2.0CH	28	4K120(444)_HDR, 2.0CH
5	4K30, 5.1CH	29	4K120(444)_HDR, 5.1CH
6	4K30, 7.1CH	30	4K120(444)_HDR, 7.1CH
7	4K60(420), 2.0CH	31	FRL10G_8K_HDR, 2.0CH
8	4K60(420), 5.1CH	32	FRL10G_8K_HDR, 5.1CH
9	4K60(420),7.1CH	33	FRL10G_8K_HDR, 7.1CH
10	4K60(444), 2.0CH	34	FRL12G_8K_HDR, 2.0CH
11	4K60(444), 5.1CH	35	FRL12G_8K_HDR, 5.1CH
12	4K60(444), 7.1CH	36	FRL12G_8K_HDR, 7.1CH
13	1080P_HDR, 2.0CH	37	user1_EDID
14	1080P_HDR, 5.1CH	38	user2_EDID
15	1080P_HDR, 7.1CH	39	user3_EDID
16	4K30_HDR, 2.0CH	40	copy out1
17	4K30_HDR, 5.1CH	41	copy out2
18	4K30_HDR, 7.1CH	42	copy out3
19	4K60(420)_HDR, 2.0CH	43	copy out4
20	4K60(420)_HDR, 5.1CH	44	copy out5
21	4K60(420)_HDR, 7.1CH	45	copy out6
22	4K60(444)_HDR, 2.0CH	46	copy out7
23	4K60(444)_HDR, 5.1CH	47	copy out8
24	4K60(444)_HDR, 7.1CH		

9. Web GUI User Guide

The Matrix can be controlled by Web GUI. The operation method is shown as below:

Step 1: Get the current IP Address.

The default IP address is 192.168.0.100. You can get the current Matrix IP address in two ways:

The first way: You can get the IP address via panel buttons. On the initial LCD display, press "MENU" button to enter the first level menu. Then press "UP/DOWN" button to select "SETUP", and press "ENTER" to enter the second level menu. Then press "UP/DOWN" button to select "IP INFO", and press "ENTER" to check current IP address.

The second way: You can get the IP address via RS-232 control. Send the command "r ipconfig!" through an ASCII Command tool, then you'll get the feedback information as shown below:

```
IP Mode: Static
IP: 192.168.0.100
Subnet Mask: 255.255.255.0
Gateway: 192.168.0.1
TCP/IP port=8000
Telnet port=23
Mac address: 00:1C:91:03:80:01
```

IP:192.168.0.100 in the above figure is the IP Address of the Matrix (the IP address is variable, depending on what the specific machine returns).

For the details of ASCII control, please refer to "10. RS-232 Control Command".

Step 2: Connect the TCP/IP port of the Matrix to a PC with an UTP cable, and set the IP address of the PC to be in the same network segment with the Matrix.

Step 3: Input the IP address of the Matrix into your browser on the PC to enter Web GUI page. After entering the Web GUI page, there will be a Login page, as shown below:

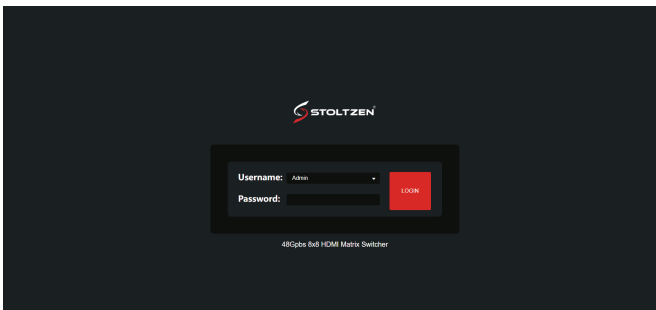

Select the username "Admin", enter the password "admin", and select the desired language. Then click the "LOGIN" button and the following Status page will appear.

■ Status Page

The Status page provides basic information about the Model, the installed firmware version and the network settings of the device.

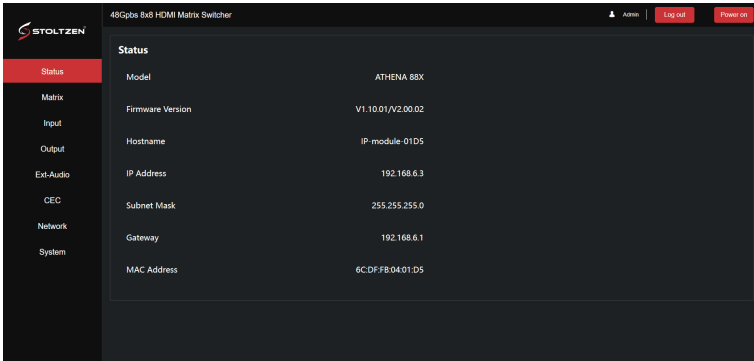

■ Matrix Page

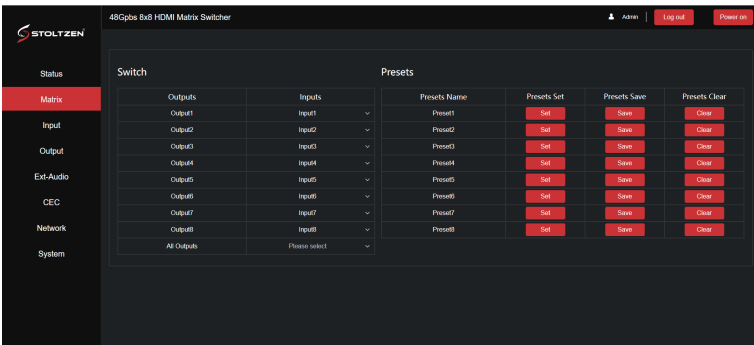

You can do the following operations on the Matrix page:

- ① **Switch:** Select the input signal source to output. The display name of each Input and Output can be modified in Input page and Output page.
- ② **Presets:** Set, save and clear the presets.

All Output: The set of All Output is available to all outputs above. You can select an input source for All Output to be used for 1~8 outputs.

The Input drop-down list shows all input sources. Click Input drop-down menu and select the input signal source which will be transmitted to the corresponding output.

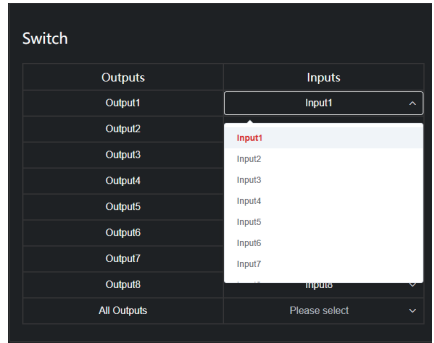

Preset1 matches with the group of Output1 and the assigned Input. Click Set button to set this preset. You can save or clear it via clicking Save or Clear.

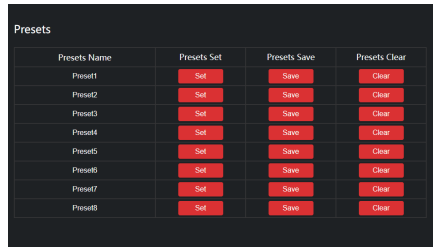

Each group of the Output and Input can be set, save and clear on the page. 8 presets are allowed to be set.

■ Input Page

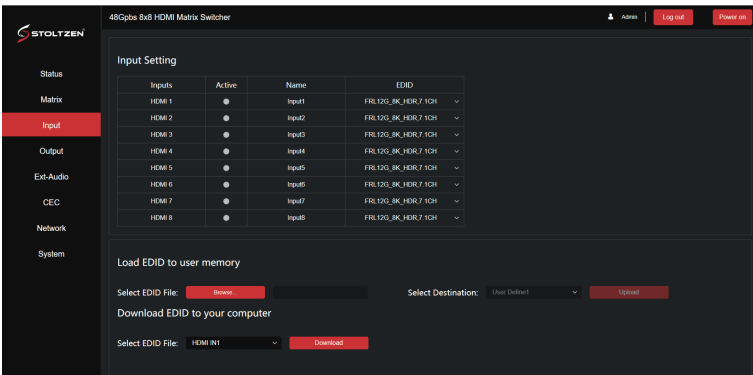

You can do the following operations on the Input page:

- ① **Input:** Input channel of the device.
- ② **Active:** It indicates whether the channel is connected to a signal source. It is green if the input signal is detected, and gray if no signal.
- ③ **Name:** The input channel's name. You can modify it by entering the corresponding name (max length: 32 characters) in the input box.

- ④ **EDID:** It indicates the current EDID of the device. You can click the drop-down menu to select other EDIDs.
- ⑤ **Load EDID to user memory:** Set EDID for the User. Click the “Browse” button, then select the bin file. If you select the wrong EDID file, there will be a prompt, as shown in the following figure:

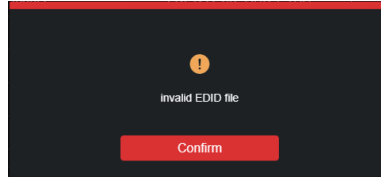

Make sure to select the correct file, then you can check the name of the selected file. Then select destination “User Define1/User Define2/User Define3”, and click “Upload”.

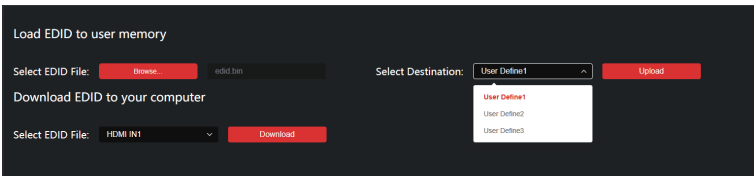

After successful setting, it will prompt as follows:

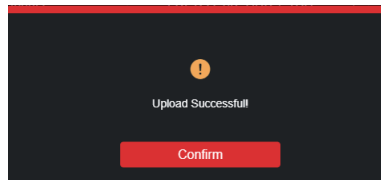

⑥ **Download EDID to your computer:**

If you want to download the existing EDID, click the drop-down box of “Select EDID File” to select the input channel you want, and then click “Download” to save the corresponding EDID file to your computer.

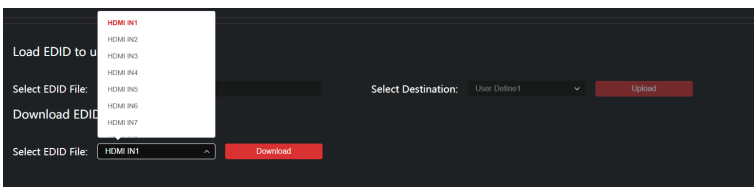

■ Output Page

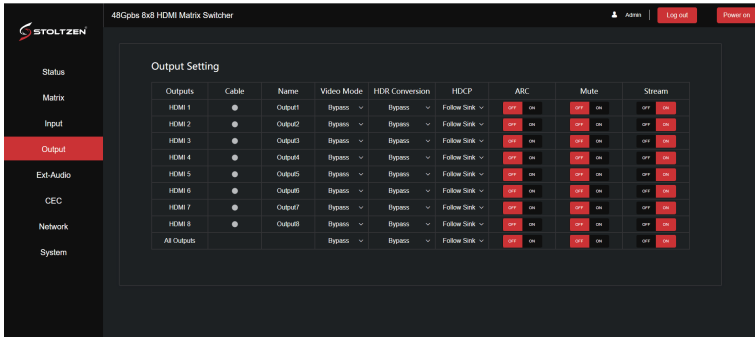

You can do the following operations on the Output page:

- ① **Outputs:** Output channel of the device.
 - All Output:** The set of All Output is available to all outputs above if you select a value from the drop-down list.
- ② **Cable:** It indicates the connection status of output ports. When the output port is connected to the display, it shows green, otherwise, it shows gray.
- ③ **Name:** The output channel's name. You can modify it by entering the corresponding name (max length: 32 characters) in the input box.
- ④ **Video Mode:** This product support video downscaling on all outputs. It will output the proper video resolution according to the selected mode. Click the drop-down menu and set the video scaler mode you need.

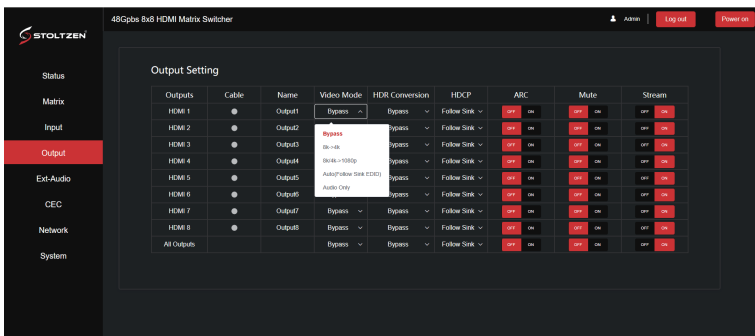

There are five options to be selected:

- **Bypass (Default):** It means the output resolution follows the input source.
- **8K -> 4K:** Downscales any 8K signal to 4K.
- **8K/4K -> 1080p:** Downscales any 8K/4K signal to 1080p.
- **Auto (Follow Sink EDID):** It means the output resolution is according to the EDID of the corresponding display device.
- **Audio Only:** Only output audio in this mode.

The example of video mode is shown as below.

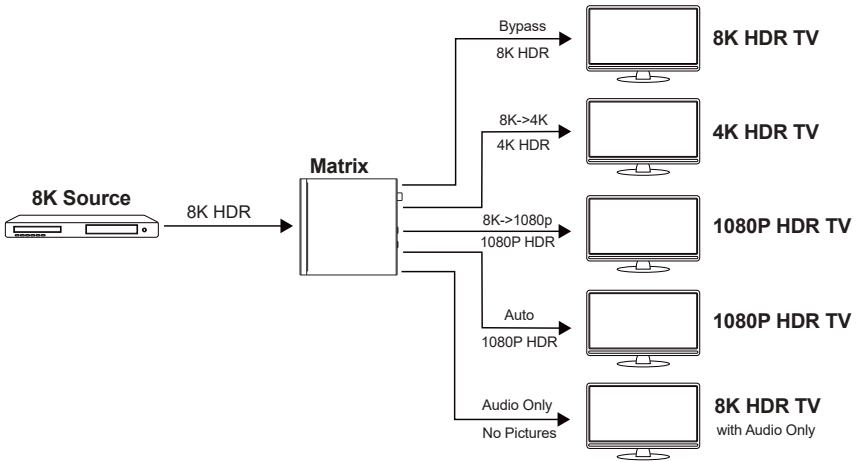

⑤ **HDR Conversion:** This product supports HDR to SDR convert on all outputs. It will output the proper HDMI signal according to the EDID of the display device, Click the drop-down menu and set the video HDR conversion mode you need.

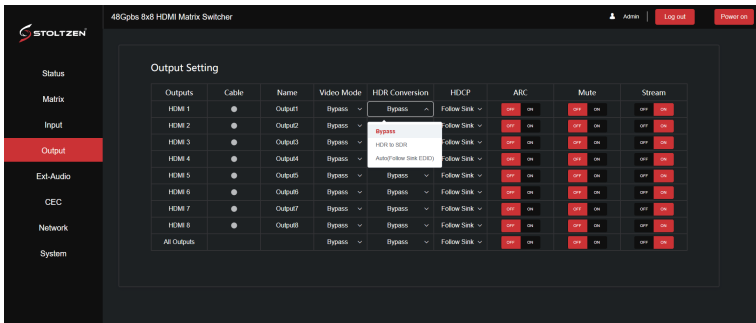

There are three options to be selected:

- **Bypass** (Default): It means the output format follows the input source.
- **HDR to SDR**: Converts HDMI signals from HDR to SDR to meet the needs of output.
- **Auto (Follow Sink EDID)**: It means the output format is according to the EDID of the corresponding display device.

The example of HDR conversion is shown as below.

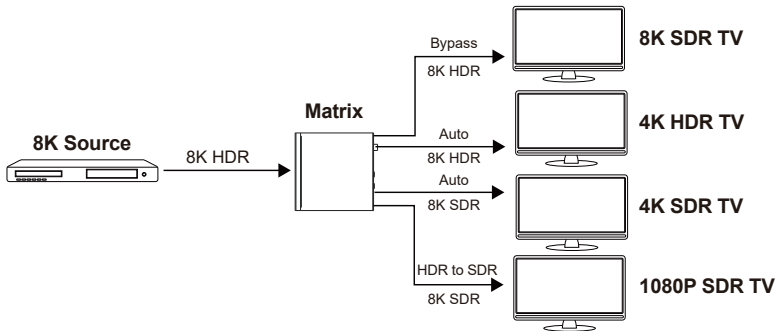

⑥ **HDCP**: Click the drop-down menu and set the HDCP for current device output.

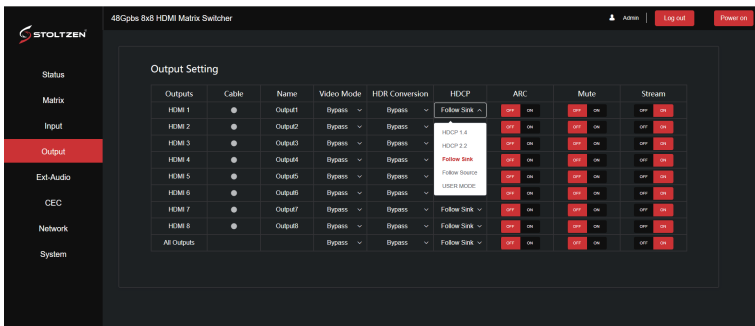

There are five options to be selected:

- **HDCP 1.4**: HDCP 1.4 compliant.
- **HDCP 2.2**: HDCP 2.2 compliant.
- **Follow Sink**: HDCP version follows the corresponding display device.
- **Follow Source**: HDCP version follows the assigned input source.
- **USER MODE**: Supports user-defined mode.

⑦ **ARC**: Click ON/OFF button to enable/disable the ARC function of the display device.

⑧ **Mute**: Click ON/OFF button to mute/unmute the audio of the corresponding output channel.

⑨ **Stream**: Click ON/OFF button to turn on/off the output stream.

■ Ext-Audio Page

You can set the audio mode on the Ext-Audio page. There are three modes: Bind to Input, Bind to Output and Audio Matrix.

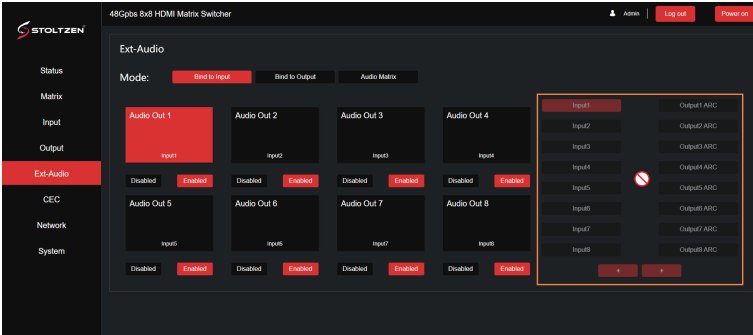

Bind to Input: The audio output follows the HDMI input. And there is a consistent one-to-one match between each HDMI input and audio output.

Click Enable/Disable button to turn on/off the audio channel.

In this mode, the input sources and output ARC can't be selected.

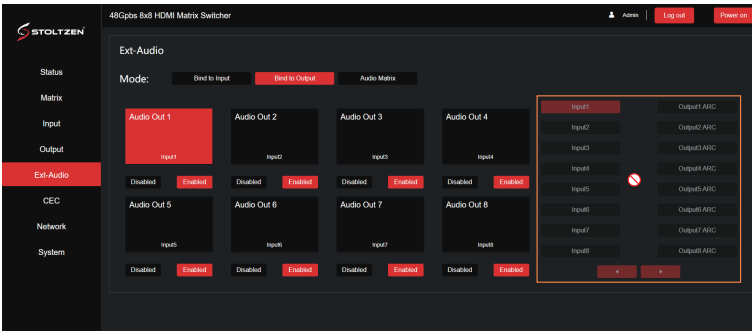

Bind to Output: The audio output follows the HDMI output. For example, if the HDMI input 3 is assigned to the HDMI output 1, the audio of AUDIO OUT 1 which follows HDMI output 1 is from HDMI input 3.

Click Enable/Disable button to turn on/off the audio channel.

In this mode, the input sources and output ARC can't be selected.

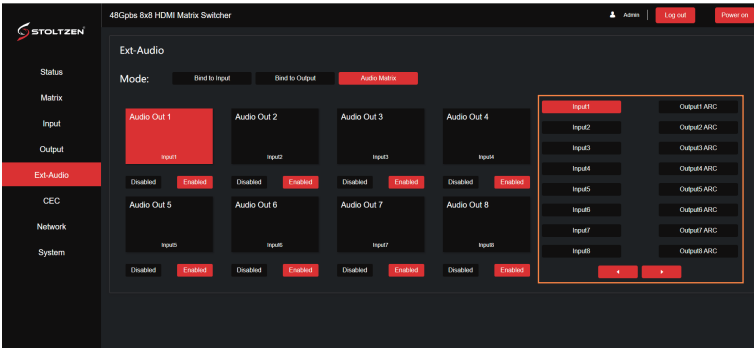

Audio Matrix: This mode allows you to matrix the extracted audio independently. Click on an Audio Out, and then select any input source or ARC audio on the right which will appear below the selected audio out. One route of audio configuration is completed.

Click Enable/Disable button to turn on/off the corresponding audio channel.

■ CEC Page

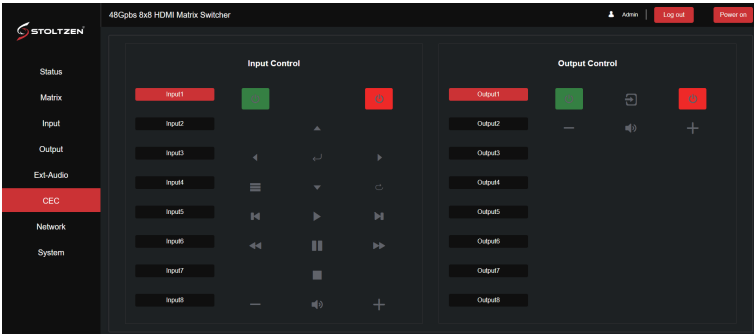

You can perform CEC management on this page. Inputs and Outputs can be controlled by clicking on the corresponding icons.

① **Input Control:** Select the input source on the left, and then click on the icons to power on, power off, return, switch, pause, fast-forward, fast-back, mute, unmute, etc.

② **Output Control:** Select the output on the left, and then click on the icons to control the operation of the display, such as power on/off, volume +/-/off, active source switching, etc.

■ Network Page

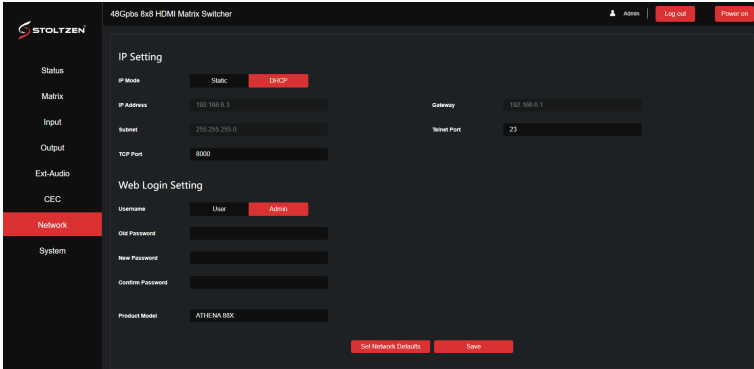

You can do the following operations on the Network page:

① Modify Network Setting:

Modify the IP Mode/IP Address/Gateway/Subnet Mask/Telnet Port as required, click “Save” to save the settings, and then it will come into effect.

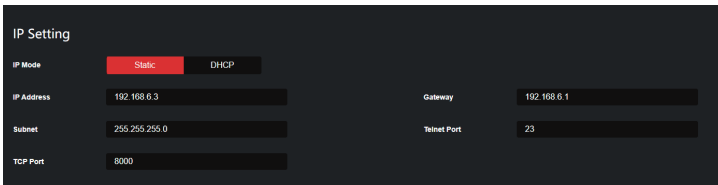

If the Mode is “Static”, you can set manually the IP Address/Gateway/Subnet/Telnet Port as required.

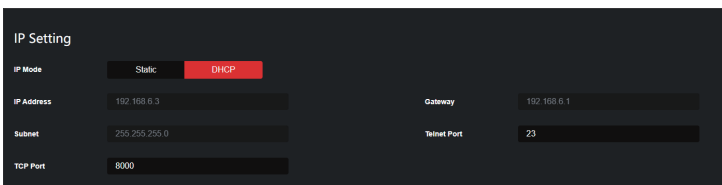

If the Mode is “DHCP”, it will search and be filled with the IP Address assigned by the router automatically. You can't modify it now.

② Modify User Password:

Click the “User” button, enter the correct Old Password, New Password, and Confirm Password, and then click “Save”. After successful modification, there will be a prompt, as shown in the following figure:

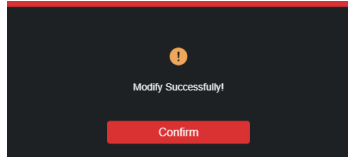
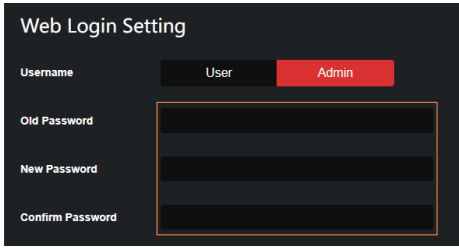

Note: Input rules for changing passwords:

- (1) The password can't be empty.
- (2) New Password can't be the same as Old Password.
- (3) New Password and Confirm Password must be the same.

③ **Set the Default Network:**

Click “Set Network Defaults”, there will be a prompt, as shown in the following figure:

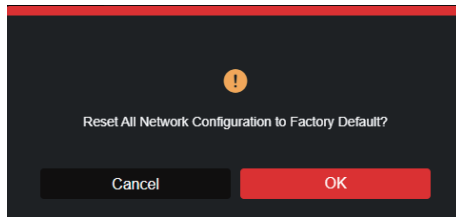

Click “OK” to search the IP Address again. After searching is completed, it will switch to the login page, the default network setting is completed.

■ **System Page**

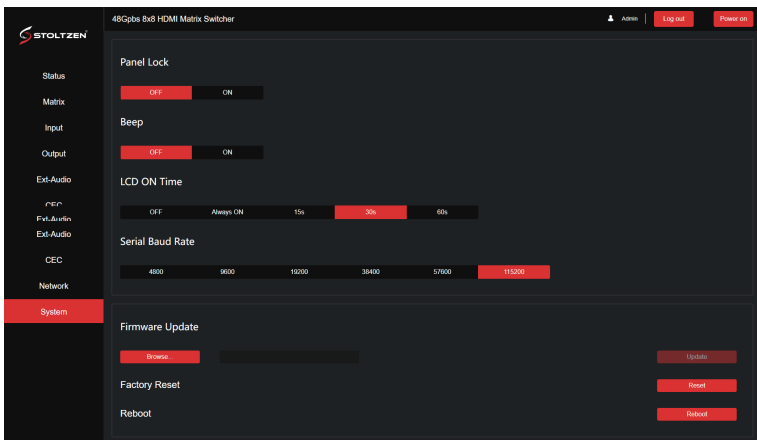

You can do the following operations on the System page:

- ① **Panel Lock:** Click “ON/OFF” to lock/unlock panel buttons. “ON” indicates that panel buttons are unavailable; “OFF” indicates panel buttons are available.
- ② **Beep:** Turn on/off the beep.
- ③ **LCD On Time:** You can turn on/off the LCD, and set the display duration time (Always ON/15s/30s/60s).
- ④ **Serial Baud Rate:** Click the value to set the Serial Baud Rate.
- ⑤ **Firmware Update:** Click “Browse” to select the update file, and then click “Update” to complete firmware update.
- ⑥ **Factory Reset:** Reset the unit to factory defaults by clicking “Reset”.
- ⑦ **Reboot:** Reboot the unit by clicking “Reboot”.

Note: After reset/reboot, it will switch to the login page.

10. RS-232 Control Command

The product also supports RS-232 control. You need a serial cable with RS-232 male head and DB9 transfer USB male head. The RS-232 head of the serial cable is connected to the RS-232 control port with DB 9 at the rear of the Matrix, and the USB head of the serial cable is connected to a PC. The connection method is as follows:

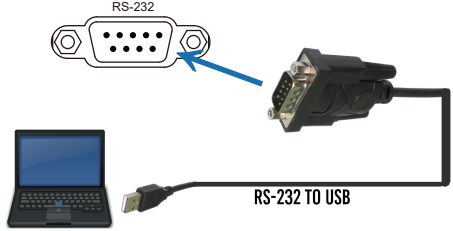

Then, open a Serial Command tool on PC to send ASCII command to control the Matrix. The ASCII command list about the product is shown as below.

ASCII Command				
Serial port protocol. Baud rate: 115200, Data bits: 8bit, Stop bits:1, Check bit: 0				
TCP/IP protocol port: 8000		Telnet port: 23		
x,y,z, XXX are parameters		Error Code describe:		
E00 -> unknown command, E01 -> parameter out of range, E02 -> get the error edid data				
Command Code	Function Description	Example	Feedback	Default Setting
System Setting				
help!	List all commands	help!		
status!	Get device current status	status!	Get the unit all status: power, beep, lock, in/ out connection, video/ audio crosspoint, edid, network status	
r type!	Get device model	r type!	8x8 HDMI2.1 Matrix	
r fw version!	Get Firmware version	r fw version!	MCU FW version x.xx.xx	
power z!	Power on/off the device, z=0~1 (z=0 power off, z=1 power on)	power 1!	power on System Initializing... Initialization Finished! MCU FW version x.xx.xx	
r power!	Get current power state	r power!	power on /power off	
s beep z!	Enable/Disable buzzer function, z=0~1 (z=0 beep off, z=1 beep on)	s beep 1!	beep on beep off	beep off

Command Code	Function Description	Example	Feedback	Default Setting
System Setting				
r beep!	Get buzzer state	r beep!	beep on / beep off	
s lock z!	Lock/Unlock front panel button, z=0~1 (z=0 lock off, z=1 lock on)	s lock 1!	panel button lock on panel button lock off	panel button lock off
r lock!	Get panel button lock state	r lock!	panel button lock on/off	
s lcd on time z!	Set LCD screen remain on time, z=0~4 (0:off 1:always, 2:15s, 3:30s, 4:60s)	s lcd on time 3!	lcd on 30 seconds	lcd on 30 seconds
r lcd mode!	Get the backlight status of lcd screen	r lcd mode!	lcd always on	
s logo1 *****!	Set the logo name displayed on the first line of LCD screen, the max character is 16	s logo1 Matrix Switch!	logo1:Matrix Switch	
reboot!	Reboot the device	reboot!	Reboot... 8x8 hdmi 2.1 matrix system initializing... initialization finished! mcu fw version : vx.xx.xx	
reset!	Reset to factory defaults	reset!	Reset to factory defaults 8x8 hdmi2.1 matrix system initializing... initialization finished! mcu fw version : vx.xx.xx	
r link in x!	Get the connection status of the x input port, x=0~8 (0=all)	r link in 1!	hdmi input 1: connect/ sync/disconnect	
r link out y!	Get the connection status of the y output port, y=0~8 (0=all)	r link out 1!	hdmi output 1: connect/ disconnect	
s save preset z!	Save switch state between all output port and the input port to preset z, z=1~8	s save preset 1!	save to preset 1	
s recall preset z!	Call saved preset z scenarios, z=1~8	s recall preset 1!	recall from preset 1	
s clear preset z!	Clear stored preset z scenarios, z=1~8	s clear preset 1!	clear preset 1	
r preset z!	Get preset z information, z=1~8	r preset 1!	video/audio crosspoint	

Command Code	Function Description	Example	Feedback	Default Setting
Output Setting				
s output y in source x!	Route input x source to output y (y=0~8, 0=all, x=1~8) x=1. input 1, x=2. input 2 x=3. input 3, x=4. input 4 x=5. input 5, x=6. input 6 x=7. input 7, x=8. input 8	s output 1 in source 1!	output1->input1	output1->input1 output2->input2 output7->input7 output8->input8
r output y in source!	Get output y selected input source (y=0~8, 0=all)	r output 1 in source!	output1->input1	
s output y hdcp x!	Set output hdcp (y=0~8, x=1~5) x=1. HDCP 1.4 x=2. HDCP 2.2 x=3. Follow sink x=4. Follow source x=5. USER MODE	s output 1 hdcp 2!	output 1 HDCP: HDCP 2.2	Follow sink
r output y hdcp!	Get output y hdcp status. (y=0~8, 0=all)	r output 1 hdcp!	output 1 HDCP: HDCP 2.2	
s output y stream x!	Set output y stream enable/disable (y=0~8, 0=all, x=0~1) x=0. stream disable x=1. stream enable	s output 1 stream 1!	output 1 stream: Enable	Enable
r output y stream!	Get output y stream status. (y=0~8, 0=all)	r output 1 stream!	output 1 stream: Enable	
s output y video mode x!	Set output y port video mode (y=0~8, 0=all, x=1~5) x=1. pass-through x=2. 8k->4k x=3. 8k/4k->1080p x=4. auto (follow sink EDID) x=5. audio only	s output 1 video mode: 2!	output 1 video mode: 8k->4k	pass-through
r output y video mode!	Get output y port video mode y=0~8 (0=all)	r output 1 video mode!	output 1 video mode: 8k->4k	
s output y hdr x!	Set output y port HDR to SDR mode (y=0~8, 0=all, x=1~3) x=1. pass-through x=2. HDR to SDR x=3. auto (follow sink EDID)	s output 1 hdr 2!	output 1 HDR mode: HDR to SDR	pass-through
r output y hdr!	Get output y port HDR to SDR mode y=0~8 (0=all)	r output 1 hdr!	output 1 HDR mode: HDR to SDR	
s output y arc x!	Set output y ARC on/off (y=0~8, 0=all, x=0~1) x=0. off x=1. on	s output 1 arc 0!	output 1 arc: off	off
r output y arc!	Get output y ARC status y=0~8 (0=all)	r output 1 arc!	output 1 arc: off	
s output y audio mute x!	Set output y audio mute on/off (y=0~8, 0=all, x=0~1) x=0. mute off x=1. mute on	s output 1 audio mute 0!	output 1 audio mute: off	off
r output y audio mute!	Get output y audio mute status (y=0~8, 0=all)	r output 1 audio mute!	output 1 audio mute: off	

Command Code	Function Description	Example	Feedback	Default Setting
EDID Setting				
s input x EDID z!	Set HDMI input x EDID mode (x=0~8, z=1~39) z=1. 1080P, 2.0CH, z=2. 1080P, 5.1CH, z=3. 1080P, 7.1CH, z=4. 4K30, 2.0CH, z=5. 4K30, 5.1CH, z=6. 4K30, 7.1CH, z=7. 4K60(420), 2.0CH, z=8. 4K60(420), 5.1CH, z=9. 4K60(420), 7.1CH z=10. 4K60(444), 2.0CH, z=11. 4K60(444), 5.1CH, z=12. 4K60(444), 7.1CH z=13. 1080P_HDR, 2.0CH, z=14. 1080P_HDR, 5.1CH, z=15. 1080P_HDR, 7.1CH z=16. 4K30_HDR, 2.0CH, z=17. 4K30_HDR, 5.1CH, z=18. 4K30_HDR, 7.1CH z=19. 4K60(420)_HDR, 2.0CH, z=20. 4K60(420)_HDR, 5.1CH, z=21. 4K60(420)_HDR, 7.1CH z=22. 4K60(444)_HDR, 2.0CH, z=23. 4K60(444)_HDR, 5.1CH, z=24. 4K60(444)_HDR, 7.1CH z=25. 4K120(420)_HDR, 2.0CH, z=26. 4K120(420)_HDR, 5.1CH, z=27. 4K120(420)_HDR, 7.1CH z=28. 4K120(444)_HDR, 2.0CH, z=29. 4K120(444)_HDR, 5.1CH, z=30. 4K120(444)_HDR, 7.1CH z=31. FRL10G_8K_HDR, 2.0CH, z=32. FRL10G_8K_HDR, 5.1CH, z=33. FRL10G_8K_HDR, 7.1CH z=34. FRL12G_8K_HDR, 2.0CH, z=35. FRL12G_8K_HDR, 5.1CH, z=36. FRL12G_8K_HDR, 7.1CH, z=37. user1_EDID, z=38. user2_EDID, z=39. user3_EDID	s input 1 EDID 36!	input 1 EDID: FRL12G_8K_HDR, 7.1CH	FRL12G_8K_HDR, 7.1CH
s input x edid copy output y!	Set HDMI input x EDID copy from output y (x=0~8, 0=all, y=1~8)	s input 1 edid copy output 1!	input 1 EDID: copy from output 1	
r input x EDID!	Get input x EDID mode (x=0~8, 0=all)	r input 1 EDID!	input 1 EDID: RL12G_8K_HDR,7.1CH	
s user x edid 00 FF FF ...!	Set user x EDID data (x=1~3) x=1. user1_EDID x=2. user2_EDID x=3. user3_EDID	s user 1 edid 00 FF FF FF FF ...!	user 1 EDID data: 00 FF FF FF FF FF FF 00	
r user x edid!	Get user x EDID data (x=1~3)	r user 1 edid!	user 1 EDID data: 00 FF FF FF FF FF FF 00	

Command Code	Function Description	Example	Feedback	Default Setting
Ext-audio Setting				
s output y exa x!	Set output y ext-audio enable/disable (y=0~8, 0=all, x=0~1) x=0. ext-audio disable x=1. ext-audio enable	s output 1 exa 1!	output 1 ext-audio: Enable	Enable
r output y exa!	Get output y ext-audio enable/disable status (y=0~8, 0=all)	r output 1 exa!	output 1 ext-audio: Enable	
s output exa mode x!	Set output ext-audio mode (x=0~2) x=0. bind to input mode x=1. bind to output mode x=2. matrix mode	s output exa mode 0!	output ext-audio mode: bind to input	bind to input
r output exa mode!	Get output ext-audio mode	r output exa mode!	output ext-audio mode: bind to input	
s output y exa in source x!	Route input source audio to output ext-audio y (y=0~8, x=1~16) x=1. input 1, x=2. input 2, x=3. input 3, x=4. input 4, x=5. input 5, x=6. input 6, x=7. input 7, x=8. input 8, x=9. output 1 ARC, x=10. output 2 ARC, x=11. output 3 ARC, x=12. output 4 ARC, x=13. output 5 ARC, x=14. output 6 ARC x=15. output 7 ARC, x=16. output 8 ARC	s output 1 exa in source 1!	output1 ext-audio ->input1	output1 ext-audio->input1 output2 ext-audio->input2 output7 ext-audio->input7 output8 ext-audio->input8
r output y exa in source!	Get output y ext-audio selected input source (y=0~8, 0=all)	r output 0 exa in source!	output1 ext-audio->input1 output2 ext-audio->input2 output7 ext-audio->output7 ARC output8 ext-audio->output8 ARC	
CEC Setting				
s cec in x on!	Set input x power on by CEC, x=0~8 (0=all input)	s cec in 1 on!	input 1 power on	
s cec in x off!	Set input x power off by CEC, x=0~8 (0=all input)	s cec in 1 off!	input 1 powe off	
s cec in x menu!	Set input x open menu by CEC, x=0~8 (0=all input)	s cec in 1 menu!	input 1 open menu	
s cec in x back!	Set input x back operation by CEC, x=0~8 (0=all input)	s cec in 1 back!	input 1 back operation	

Command Code	Function Description	Example	Feedback	Default Setting
CEC Setting				
s cec in x up!	Set input x menu up operation by CEC, x=0~8 (0=all input)	s cec in 1 up!	input 1 menu up operation	
s cec in x down!	Set input x menu down operation by CEC, x=0~8 (0=all input)	s cec in 1 down!	input 1 menu down operation	
s cec in x left!	Set input x menu left operation by CEC, x=0~8 (0=all input)	s cec in 1 left!	input 1 menu left operation	
s cec in x right!	Set input x menu right operation by CEC, x=0~8 (0=all input)	s cec in 1 right!	input 1 menu right operation	
s cec in x enter!	Set input x menu enter by CEC, x=0~8 (0=all input)	s cec in 1 enter!	input 1 menu enter operation	
s cec in x play!	Set input x play by CEC, x=0~8 (0=all input)	s cec in 1 play!	input 1 play operation	
s cec in x pause!	Set input x pause by CEC, x=0~8 (0=all input)	s cec in 1 pause!	input 1 pause operation	
s cec in x stop!	Set input x stop by CEC, x=0~8 (0=all input)	s cec in 1 stop!	input 1 stop operation	
s cec in x rew!	Set input x rewind by CEC, x=0~8 (0=all input)	s cec in 1 rew!	input 1 rewind operation	
s cec in x mute!	Set input x volume mute by CEC, x=0~8 (0=all input)	s cec in 1 mute!	input 1 volume mute	
s cec in x vol-!	Set input x volume down by CEC, x=0~8 (0=all input)	s cec in 1 vol-!	input 1 volume down	
s cec in x vol+!	Set input x volume up by CEC, x=0~8 (0=all input)	s cec in 1 vol+!	input 1 volume up	
s cec in x ff!	Set input x fast forward by CEC, x=0~8 (0=all input)	s cec in 1 ff!	input 1 fast forward operation	
s cec in x previous!	Set input x previous by CEC, x=0~8 (0=all input)	s cec in 1 previous!	input 1 previous operation	
s cec in x next!	Set input x next by CEC, x=0~8 (0=all input)	s cec in 1 next!	input 1 next operation	
s cec hdmi out y on!	Set hdmi output y power on by CEC, y=0~8 (0=all hdmi output)	s cec hdmi out 1 on!	hdmi output 1 power on	
s cec hdmi out y off!	Set hdmi output y power off by CEC, y=0~8 (0=all hdmi output)	s cec hdmi out 1 off!	hdmi output 1 power off	
s cec hdmi out y mute!	Set hdmi output y volume mute by CEC, y=0~8 (0=all hdmi output)	s cec hdmi out 1 mute!	hdmi output 1 volume mute	
s cec hdmi out y vol-!	Set hdmi output y volume down by CEC, y=0~8 (0=all hdmi output)	s cec hdmi out 1 vol-!	hdmi output 1 volume down	
s cec hdmi out y vol+!	Set hdmi output y volume up by CEC, y=0~8 (0=all hdmi output)	s cec hdmi out 1 vol+!	hdmi output 1 volume up	
s cec hdmi out y active!	Set hdmi output y active source by CEC, y=0~8 (0=all hdmi output)	s cec hdmi out 1 active!	hdmi output 1 active source	

Command Code	Function Description	Example	Feedback	Default Setting
Network Setting				
r ipconfig!	Get the Current IP Configuration	r ipconfig !	IP Mode: Static IP: 192.168.0.100 Subnet Mask: 255.255.255.0 Gateway: 192.168.0.1 TCP/IP port:8000 Telnet port:23 Mac address: 00:1C:91:03:80:01	
r mac addr!	Get network MAC address	r mac addr!	Mac address: 00:1C:91:03:80:01	
s ip mode z!	Set network IP mode to static IP or DHCP, z=0~1 (z=0 Static, z=1 DHCP)	s ip mode 0!	Set IP mode:Static. (Please use "s net reboot!" command to apply new config!)	
r ip mode!	Get network IP mode	r ip mode!	IP mode: Static	
s ip addr xxx.xxx.xxx!	Set network IP address	s ip addr 192.168.0.100!	Set IP address:192.168.0.100 (Please use "s net reboot!" command to apply new config!) DHCP on, Device can't config static address, set DHCP off first.	
r ip addr!	Get network IP address	r ip addr!	IP address:192.168.0.100	
s subnet xxx.xxx.xxx!	Set network subnet mask	s subnet 255.255.255.0!	Set subnet mask:255.255.255.0 (Please use "s net reboot!" command to apply new config!) DHCP on, Device can't config subnet mask, set DHCP off first.	
r subnet!	Get network subnet mask	r subnet!	Subnet Mask:255.255.255.0	
s gateway xxx.xxx.xxx!	Set network gateway	s gateway 192.168.0.1!	Set gateway:192.168.0.1 (Please use "s net reboot!" command to apply new config!) DHCP on, Device can't config gateway, set DHCP off first.	
r gateway!	Get network gateway	r gateway!	Gateway:192.168.0.1	
s tcp/ip port x!	Set network TCP/IP port (x=1~65535)	s tcp/ip port 8000!	Set TCP/IP port:8000	
r tcp/ip port!	Get network TCP/IP port	r tcp/ip port!	TCP/IP port:8000	
s telnet port x!	Set network telnet port (x=1~65535)	s telnet port 23!	Set Telnet port:23	

Command Code	Function Description	Example	Feedback	Default Setting
r telnet port!	Get network telnet port	r telnet port!	Telnet port:23	
s net reboot!	Reboot network modules	s network reboot!	Network reboot... IP Mode: Static IP: 192.168.0.100 Subnet Mask: 255.255.255.0 Gateway: 192.168.0.1 TCP/IP port=8000 Telnet port=23 Mac address: 00:1C:91:03:80:01	

11. Application Example

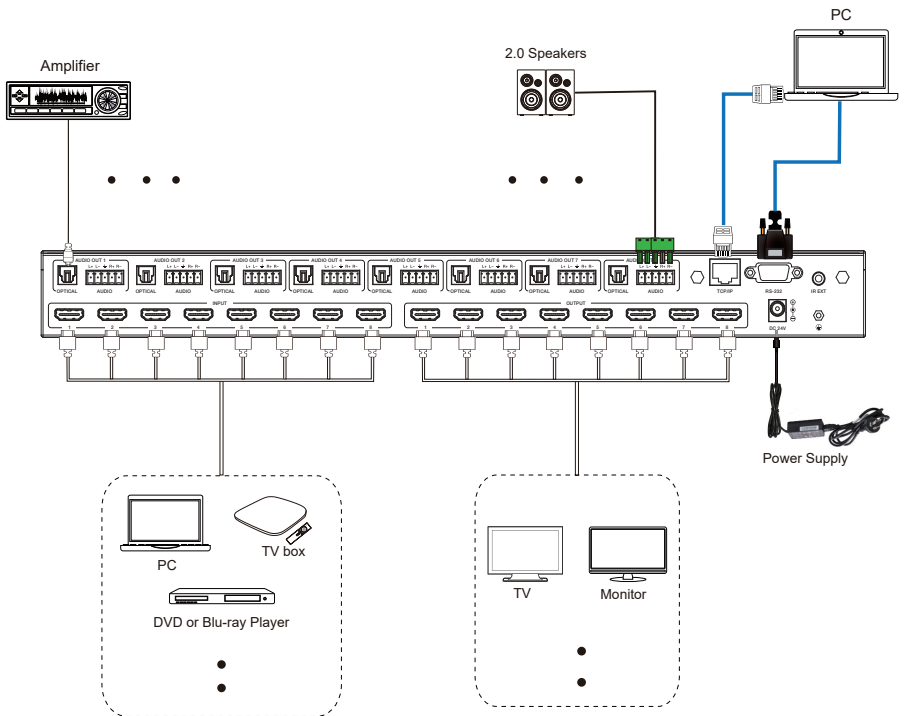

HDMI™
HIGH-DEFINITION MULTIMEDIA INTERFACE

The terms HDMI and HDMI High-Definition Multimedia interface, and the HDMI Logo are trademarks or registered trademarks of HDMI Licensing LLC in the United States and other countries.