

Network Cable Fiber

LinkIT fiber patch OM4 LC/LC Magenta 60m

Duplex | MM | LSZH

Product number: FPD54LPLP-600

Product Description

LinkIT fiber cord OM4 is an optimized 50 multimode fiber cable for 10 Gbps up to 100 Gbps data transmission: 10 Gbps up to 550 m, or 100 Gbps up to 125 m

Main Specifications

Brand	LinkIT
Color	Magenta
Length (m)	60
Category	OM4
Connector type 1	LC
Connector type 2	LC
Polishing contact 1	UPC
Polishing contact 2	UPC
Cable type	Duplex
Number of fibers	2
Wave length (nm)	850/1300
Core Diameter (um)	50/125 - Multimode

Extended Specifications

Jacket material	LSZH
Anti-kink sleeve	Moulded
Optical Return Loss (dB)	≥35dB
Insertion Loss (dB)	≤0.3dB
Operating Temperature	-40°C ~ +75°C



Storage Temperature	-40°C ~ +75°C
Cable Diameter (mm)	2
Fire properties	IEC-60332-3-24, IEC 60332-1-2
Halogenfree	✓
Fire retardant version	✓
Bending radius (mm)	20
Tensile loads (N)	150
Certifications	CE, RoHS

Single packaging

Unit	PCE
Quantity	1

Dimensional Sketches

LinkIT LinkIT FiberPatch OM4 LC/LC Magenta

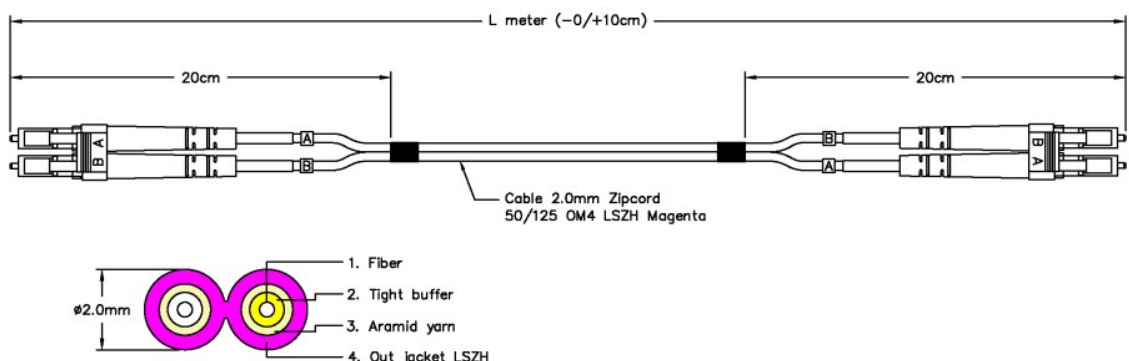

Specifications			
Connector type:	LC-LC	Insertion loss:	≤0.3dB
Fiber mode:	OM4 50/125	Return loss:	≥35dB
Fiber grade:	G.651.1	Wave length:	850/1300nm
Polish type:	PC	Optimized Data rate:	1Gb/s over 1040m / 10Gb/s over 550m
Cable jacket:	LSZH	Durability:	500 matings
Color:	Magenta	Operating/storage temp:	-40°C ~ +75°C
Cable diameter:	2mm	Fire properties:	Fire retardant and halogen-free IEC 60332-3-24, IEC 60332-1-2, IEC 61034, IEC 60754-1
Minimum bend radius:	20mm	IEC standards:	All CENELEC standards required
Tensile loads:	150N		

